

E-CONNECT

&

E-PEX

USER MANUAL

Content

1、 Picture of E-CONNECT	2
2、 Symbols Used	3
3、 Scope of application	4
4、 Contraindications	4
5、 Warnings	4
6、 E-CONNECT charging	4
7、 Install the contra-angle	5
8、 Install the file	6
9、 E-CONNECT control operation	7
10、 Picture of E-PEX	15
11、 APEX LOCATOR charging	16
12、 Install the APEX LOCATOR	17
13、 Function checking of APEX LOCATOR	18
14、 Volume control of APEX LOCATOR	19
15、 Setting the reference point	20
16、 The instruction of APEX LOCATOR display	20
17、 Connect	22
18、 Connection operation	23
19、 Display the root canal on E-CONNECT	24
20、 Combination Function	24
21、 Cleaning, Disinfection and Sterilization	26
22、 Technical specifications	31
23、 EMC Table	33
24、 Statement	36

E-CONNECT part



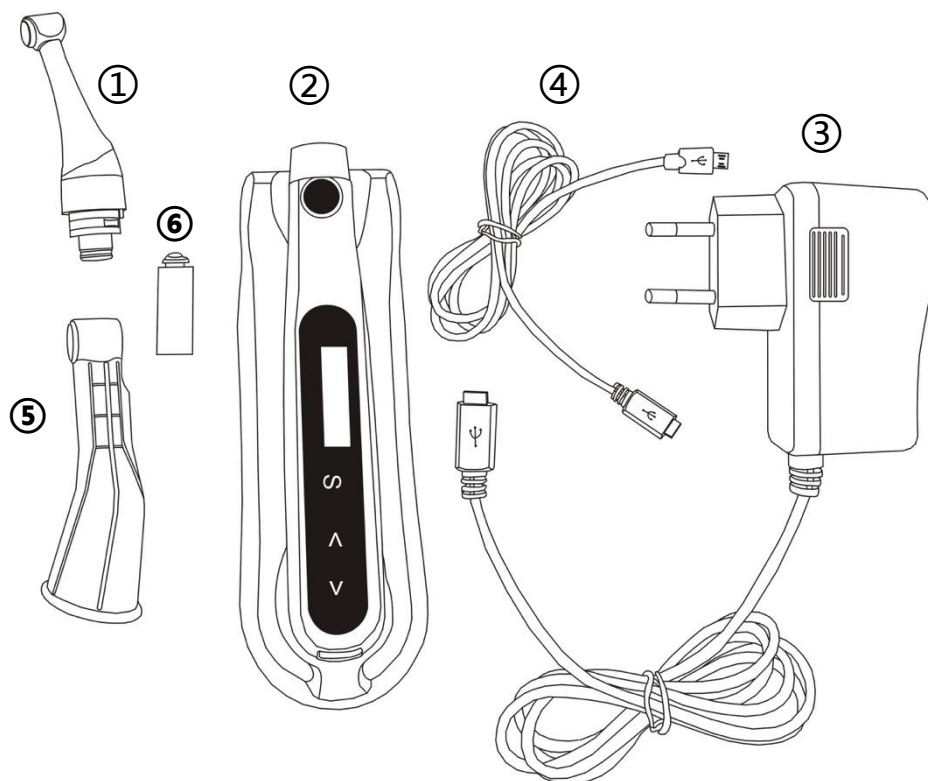

















1、Picture of E-CONNECT



Accessories list

- ① Contra-angle
- ② Motor Handpiece
- ③ Adapter
- ④ Data transfer cable
- ⑤ Silicon Sleeves
- ⑥ Spray Nozzle

2、 Symbols Used

warning 	If the instructions are not followed properly, operation may lead to hazards for the product or the user/patient.
note 	Additional information, explanation of operation and performance.
	Serial number
	Catalogue number
	Manufacturer
	Date of manufacture
	Safety class II device
	Type BF applied part
	CE marking
	DC current
	WEEE (waste of electrical and electronic equipment) directive marking
	Store in a dry place
	Consult instructions for use
	Can be autoclaved up to a maximum temperature of 134° Celsius
	Authorized Representative in the European Community
	Temperature limitation
	Relative humidity
	Atmospheric pressure
	Only applicable to indoor
	Washer-disinfector for thermal disinfection
	Manufacturer's LOGO

3、 Scope of application

Use for dental root canal treatment using endodontic instruments in torque controlled continuous rotation and in reciprocating movement.

FOR DENTAL USE ONLY!

4、 Contraindications

Safety and effectiveness have not been established in pregnant women and children.

5、 Warnings



Read the following warnings before use:

- 1、 The device must not be placed in humid surroundings or anywhere where it can come into contact with any type of liquids.
- 2、 Do not expose the device to direct or indirect heat sources. The device must be operated and stored in a safe environment.
- 3、 The device requires special precautions with regard to electromagnetic compatibility (EMC) and must be installed and operated in strict compliance with the EMC information. In particular, do not use the device in the vicinity of fluorescent lamps, radio transmitters, remote controls, portable or mobile RF communication devices and do not charge, operate or store at high temperatures. Comply with the specified operating and storage conditions.
- 4、 Gloves and a rubber dam are compulsory during treatment.
- 5、 If irregularities occur in the device during treatment, switch it off. Contact the agency.
- 6、 Never open or repair the device yourself , otherwise, void the warranty.

6、 E-CONNECT charging



The number of cells in the battery shows the current amount of power available. When it is only one please charge.

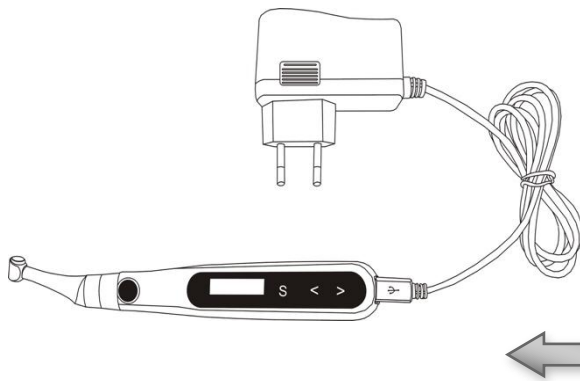

Connect the handle and adapter as shown.



Only the original adapter could be used.



The screen will show  indicate being charging.

Warning

Away from the heat source, and make sure that there is no combustible surrounding.

When low or no power charge the device , Charging intermittently for short duration multiple times will reduce the battery life

Do not use other power adapter to charge the device, otherwise it will damage the device.

Do not use other battery for the device , otherwise it will damage the device.

7、 Installation of the contra-angle

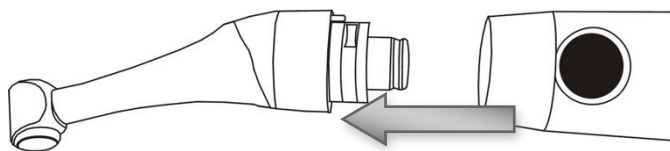

Connect the contra-angle and handle properly.

*Make sure the motor is stopped when install the contra-angle.

*Use the manufacturer specific contra-angle

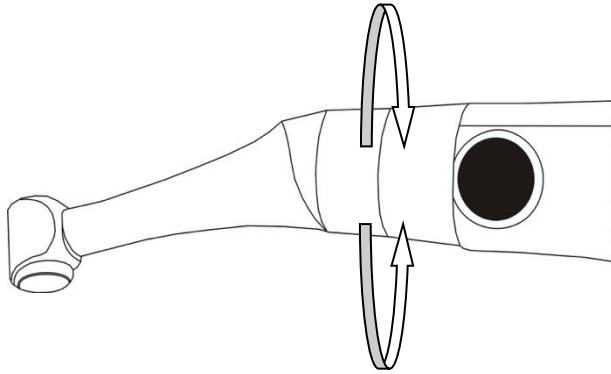

The contra angle can be 340 degrees rotated without take off

Make it easy to watch the LCD in treatment by rotating the contra-angle.

Warning : 

Make sure the assembly is connected properly , otherwise might cause unexpected motor reverse, even hurt the patients

After connect the contra-angle and handle , pull it gently to make sure the connection is good

8、 Install the file

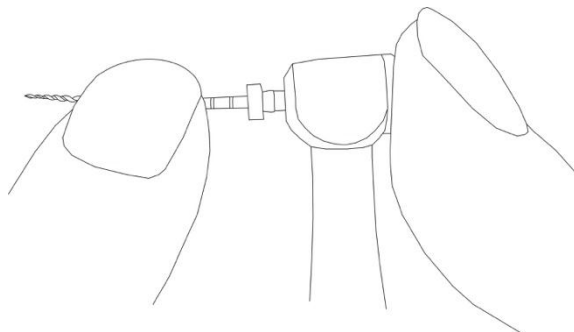

Installing the file : Insert the file and turn the file, make sure that file is inserted.

Take out the file : Keeping press the bottom and release file

Warning : 

Inspect the file head before inserting the file. Do not use the damaged file head.

Pull the file gently to make sure that the file is secure in handpiece properly, otherwise it may pop out and hurt the patient.

Note : 

Pay attention to avoid finger injuries, while inserting or removing the files.

File insertion or removal without pressing bottom of head will damage the spindle.

Make sure the motor is not running while inserting or removing the files.

9、 E-CONNECT control operation

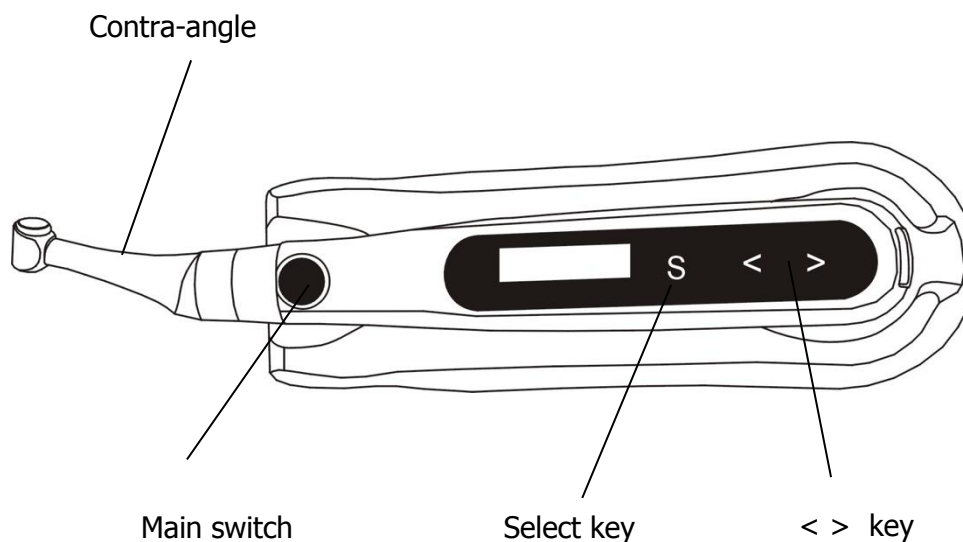

9.1 Switch control operation

Press the main switch to start the device , and select the memory by < or > key.

Then press the main switch again , test whether the device is working normally.

Warning :



Use the E-CONNECT outside the oral cavity to make sure that the device is functioning properly.

Change file on time to avoid file separation within the canal. File may separate because of cyclic / torsional fatigue.

Heavy force / hand pressure on endo motor while using may even cause file separation.

Do not press the button to release the files while the motor is running, otherwise the file may pop out and even hurt the patient.

Electromagnetic noise in surroundings environment may interfere with the device operation, do not rely on device's automatic control completely, always pay attention to the feedback from display.

Note :



If there is any abnormal functioning, stop using the device and report to company.

The file separates more easily at high speeds, please follow the manufacturer's recommendations of the speed and check the settings of the

Endo motor before use.

Do not use the files are except nickel - titanium and stainless steel.

Gloves and a rubber dam are compulsory during treatment.

Do not forget to remove the file from the Contra-angle after its use.

9.2 Keys and interface

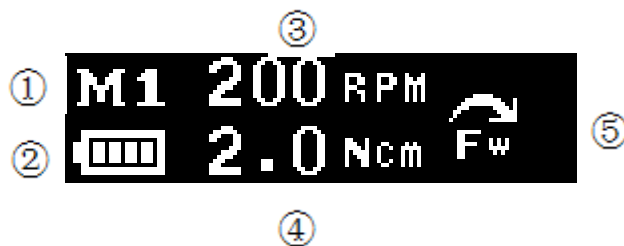
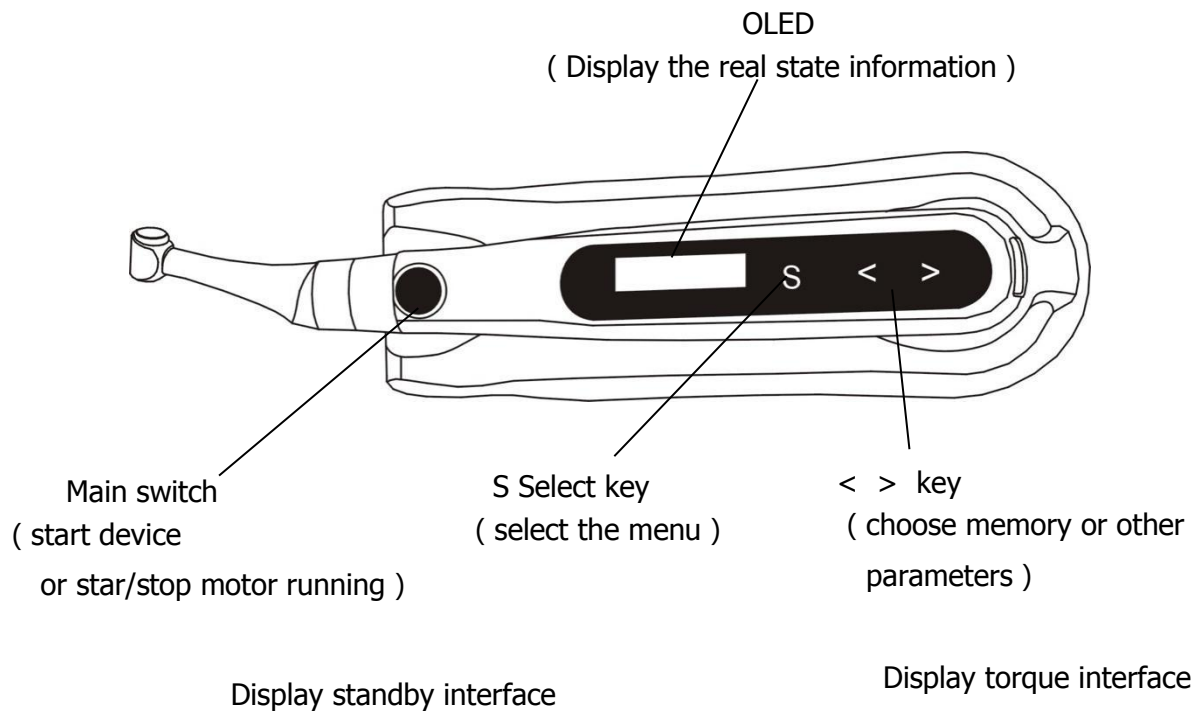

- ① The memory number
- ② Battery levels
- ③ Running speed
- ④ Reverse torque value
- ⑤ Rotation direction

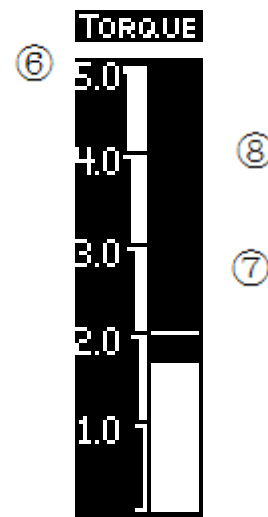

1) Start E-CONNE CT: Press the main switch

Start the device and appear the standby interface, after 3 minutes without any operation, the device will be automatically shut-down.

Press  (Main switch)  (- key) to power off.

2) Choose memory : By press </>



E-CONNECT has 10 memories(M0 to M9) , users can set the memory(combine different speed, torque and reverse direction) by themselves. Memory M0 is reciprocating mode, there are 5 units reciprocating degrees in M0, press S key to switch. M1-M9 are for normal mode.

3) Start the motor : Press the main switch again

Start the motor will appear the torque bar interface

When the motor is running, the torque bar real time monitor will appear on the LCD.

When the torque in file exceeds 70% of the set reverse torque, E-CONNECT will make a discontinuous stone alarm.

When reaches 100% of the set reverse torque, E-CONNECT will make a continuous alarm sound and carry out the reverse motion to disengage & carry out the file from the canal.

4) Stop the motor : Press main switch

E-CONNECT will stop the motor and back to standby interface.

9.3 General function setting

General function : rotate speed , reverse torque , rotate direction

Display the standby interface

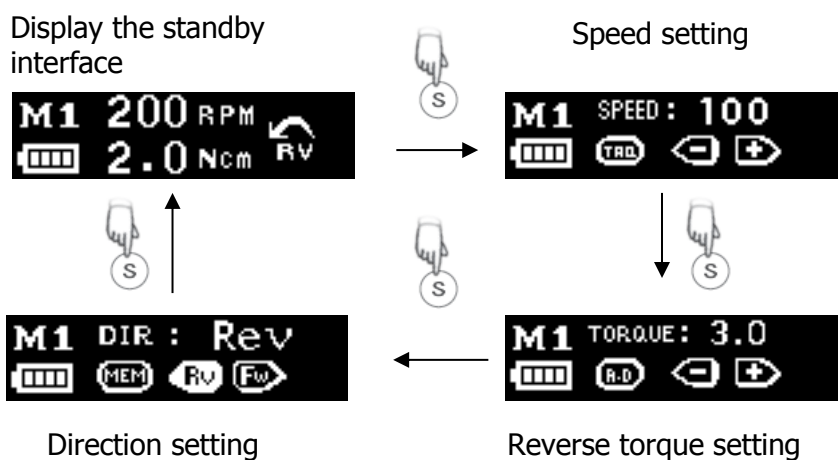

9.4 Operation steps

1. press +/-to choose a memory number
- 2.Press the S key to select a function that needs to be set
3. Press +/- to set the parameter that user need.
4. Every time the parameters are changed, it will be saved automatically.

*If exceed 5 seconds without any operation (factory setting is 5 seconds , it could be change),display will be switched to standby interface.

Speed setting

value: 120, 150, 200, 250, 300, 350, 400, 450, 500, 550, 600, 650,700,800,900,1000(rpm)

Reverse torque value setting

value: 0.5, 0.6,0.8, 1.0, 1.5, 2.0, 2.5, 3.0, 3.5, 4.0 (N·cm)

Direction setting

Fwd : Clockwise rotation Rev : Counter clockwise rotation

Note



Please set the parameters according to the file manufacturer's recommendations.

Use of torque reversal function can effectively protect the file from separating within the canal.

If the torque reversal is too frequent during the use, please recapitulate, irrigate and lubricate the root canals or increase the torque as per file manufacturer's recommendations.

9.5 Advanced settings

Advanced setting programs installed by the manufacturer are as follows-

Function	M1, M2, M3, M6, M7	M4, M5, M8, M9
Apical Reverse	ON	OFF
Auto Start & Stop	ON	ON
Apical Slow Down	OFF	ON

1. Press +/- to choose a memory number.
2. Long press the S button for more than one second into the advanced function setting interface.
3. Press S switch to next function setting.
4. Press +/- to change parameters.
5. If exceed 5 seconds without any operation (factory setting is 5 seconds, it could be change),display will switch to standby interface.

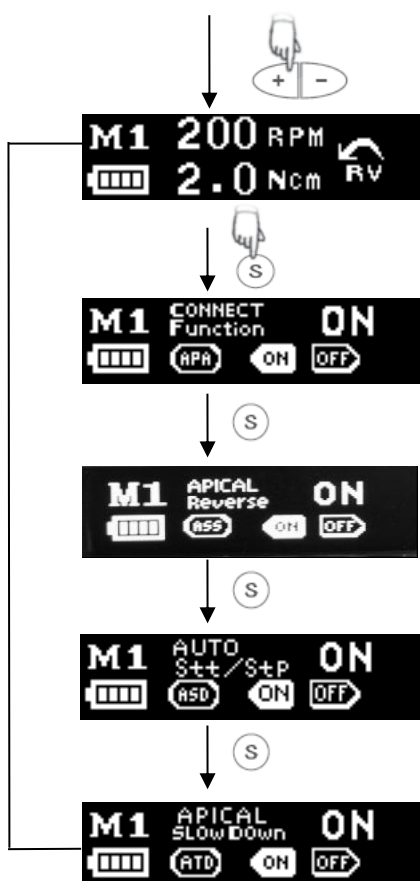

Connect Function
E-CONNECT and APEX LOCATOR connect use, the following online function will be activated.

Apical Reverse
Close to root canal apex, automatic reverse / stop.

Auto Start & Stop
When the file enters the canal orifice, the motor will start running automatically. When the file leave the canal orifice, the motor will stop automatically.

Apical Slow Down
Automatic deceleration when the file reaches to the root canal apex.

9.6 Additional function settings

Factory set as shown below:

Beep volume	Mid	Right hand or left hand	Right hand
Automatic shutdown time	10 mins	Automatic standby time	10s

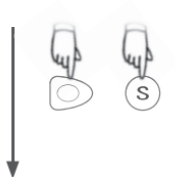

1. When the device is shutdown press key S and main switch at the same time.
2. Press S, choose one of these functions to setting.
3. Press +/- to set the parameters.
4. Press main switch, back to standby interface



↓ (S)



↓ (S)





↓ (S)



↓ (S)

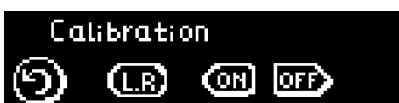

Beep Volume

Press + and - to set low, mid or high volume

Auto P.W.R

For a period of time without any operation, the device will be automatically shut down, by press + - to set automatically shut down time (1~15mins)

Hand

Change the left or right hand interface, the screen will be reversed.

Return to standby time

By press +/- to change the standby time (1-15s)

Calibration

By press +/- to select the 'ON' then press main switch to activate the calibration program.

<https://www.kadashika.jp>

9.7 Calibration

1. Install the contra angle into the E-CONNECT handpiece

Note : Do not insert the file.

2 , Enter the calibration option interface (See 9.5 Additional function settings) ,



choose 'ON'

3 , press Main switch KEY enter calibration mode , now display will show "calibration".



4, In calibration , it will display the progress



5 After calibration , the progress bar will be full , accompany 2 buzzing sound.



9.8 Error warning

while operating, E-CONNECT will detect the real time performance of the system, if the state is unsuitable, the device will self protect and inform user.



The power is too low, there will be auto power off, charge the device immediately.



Error code 00 , means overload , motor is over current , should reduce the load.



Error code 01 , means the continuous operation time is too long , motor is over heated, stop using the device for some time.

Note

Please set the functions according to the requirements as dictated by the manufacturer.

It is recommended to perform a calibration operation after each change of the bending head.

Please keep the battery in more than half when calibrating.

Do not apply pressure to the bending head during calibration.

If the error alarm has occurred, please contact the local distributor to check and repair.

E-PEX Part



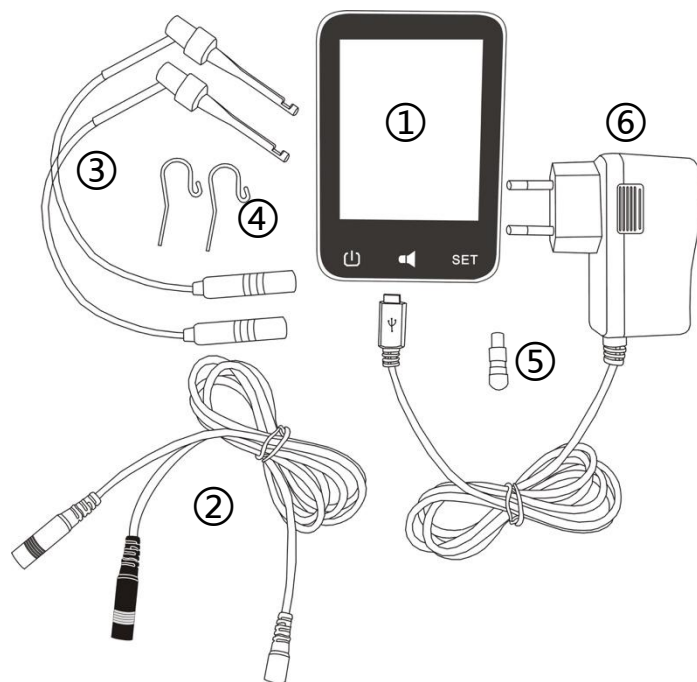











10、Picture of E-PEX









Accessories list

- 1.Apex Locator (main unit)
- 2.Measuring wire
- 3.File clip
- 4.Lip hook
- 5.Tester
- 6.Adapter

11、 Symbols Used

warning 	If the instructions are not followed properly, operation may lead to hazards for the product or the user/patient.
note 	Additional information, explanation of operation and performance.
	Serial number
	Catalogue number
	Manufacturer
	Date of manufacture
	Safety class II device
	Type BF applied part
	CE marking
	DC current
	WEEE (waste of electrical and electronic equipment) directive marking
	Store in a dry place
	Consult instructions for use
	Can be autoclaved up to a maximum temperature of 134° Celsius
	Authorized Representative in the European Community

	Temperature limitation
	Relative humidity
	Atmospheric pressure
	Only applicable to indoor
	Washer-disinfector for thermal disinfection
	Manufacturer's LOGO

12、 Scope of application

This apex locator is used to detect the apex of root canal

13、 Contraindications

Do not use this unit in conjunction with an electric scalpel or on patients who have a pacemaker.

Blocked canals cannot be accurately measured.

14、 Warnings



Read the following warnings before use:

- 1、 The device must not be placed in humid surroundings or anywhere where it can come into contact with any type of liquids.
- 2、 Do not expose the device to direct or indirect heat sources. The device must be operated and stored in a safe environment.
- 3、 The device requires special precautions with regard to electromagnetic compatibility (EMC) and must be installed and operated in strict compliance with the EMC information. In particular, do not use the device in the vicinity of fluorescent lamps, radio transmitters, remote controls, portable or mobile RF communication devices and do not charge, operate or store at high temperatures. Comply with the specified operating and storage conditions.
- 4、 Gloves and a rubber dam are compulsory during treatment.

- 5、 If irregularities occur in the device during treatment, switch it off. Contact the agency.
- 6、 Never open or repair the device yourself , otherwise, void the warranty.

15、 E-PEX Charging

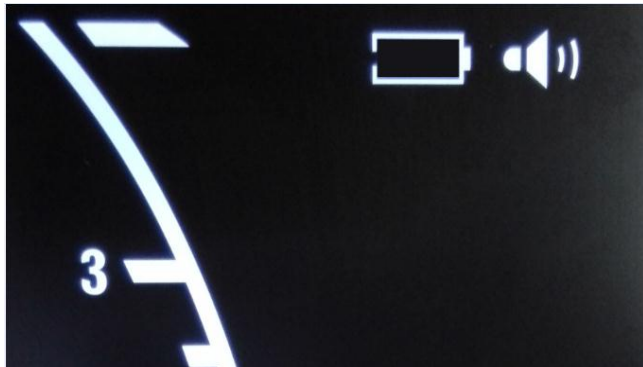

When the power indicator flash, please stop use the device to charge. We suggest user charge the device when one bar left.

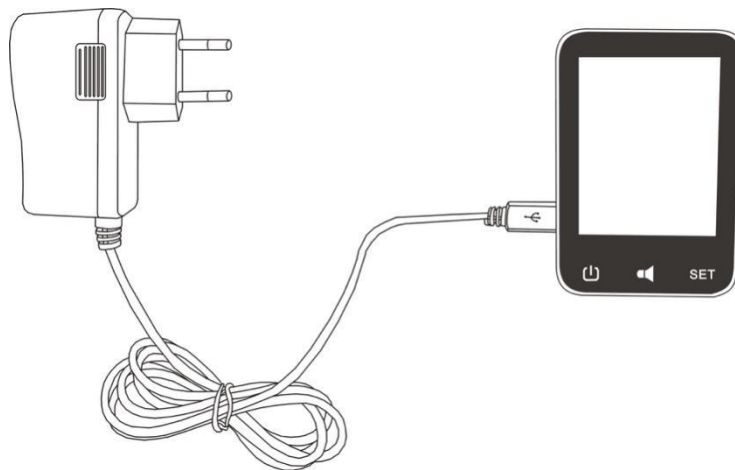

APEX LOCATOR connect with the power adaptor.

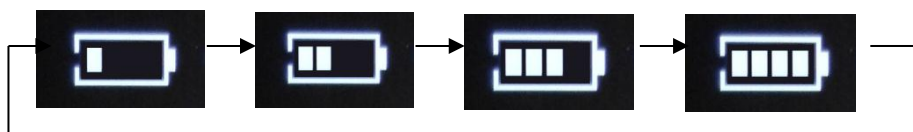

When the power indicator as shown, means the device is charging

Warning

Away from the heat source and make sure that there is no combustible surrounding.

When battery is low charge the device fully. Charging frequently in low power state for short time will reduce the battery life.

Do not use other power adapter to charge the device, otherwise it will damage the device.

Do not charge the device while using it.

Do not use other battery for the device , otherwise it will damage the device.

16、 Install the APEX LOCATOR

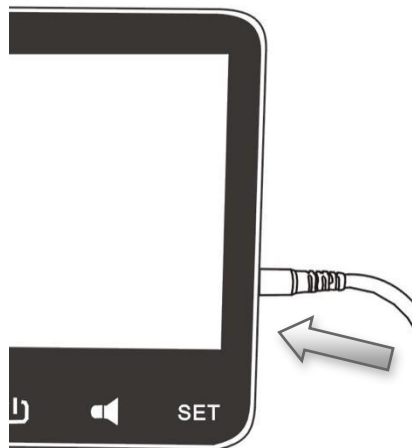

1. Insert the measuring wire into socket as shown in left picture, make sure connect properly

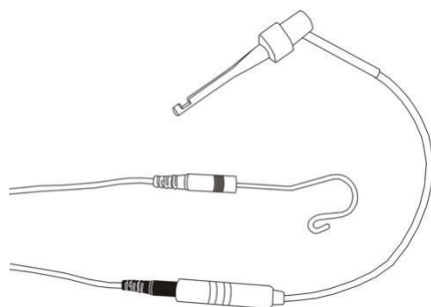

2. Connect file clip, measuring file and lip hook as shown in left picture.

Note

When installing the connecting wire, please pay attention to the orientation of the slots in the attachment part and do not apply too much force while adapting it.

Incorrect connection will result device measurement inaccurate, even cannot be used.

17、 Function checking of APEX LOCATOR

(1)



1. Press Power-Key to start APEX LOCATOR, now the display will show measuring interface.

(10 minutes without any operation, will automatically shut down the device)

(2)

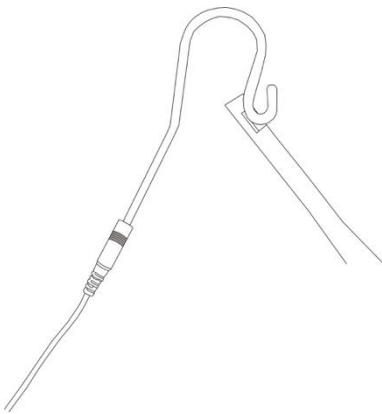

2、 Check the measuring wire, file clip, lip hook and APEX LOCATOR are connecting properly. Make file clip hook with lip hook (short circuit)

(3)



3、 Observing APEX LOCATOR display, the root canal length strip will be all lighted, and a rapid beep sound will be generated at the same time, the 'APEX' sign will be flashed. That means the APEX LOCATOR is working normally.

(4)

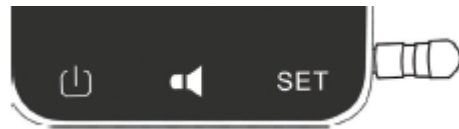

4、 It is strongly recommended to regularly control the device using the tester.

Replace the measuring wire by the tester.

The green strips shall appear and the displayed strip number shall be between "02" "03" or "04".

Note 

If the indicating is wrong , please check whether the measuring wire is properly connected.

18、 Volume control of APEX LOCATOR

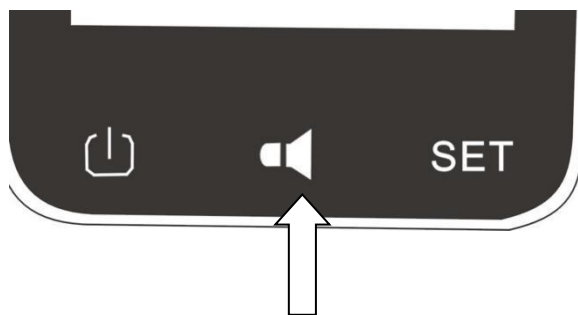

The APEX LOCATOR's volume of the key and alarm sounds can be adjusted. Press the volume keys to cycle the volume through the minor to the maximum.

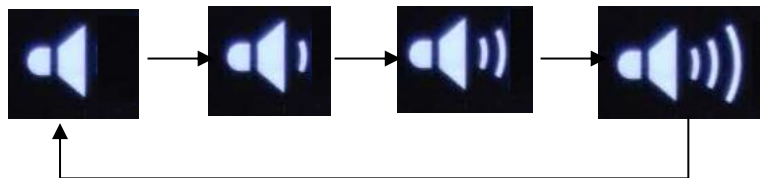

19、 Setting the reference point

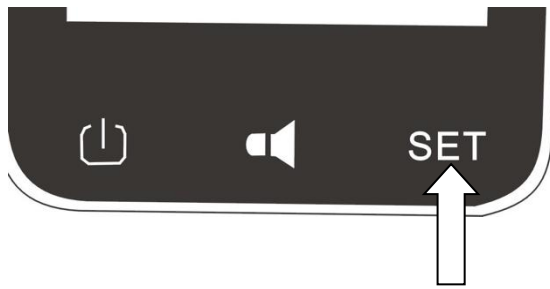

Press SET key , can setting the reference point , between 0~1.



Press SET to adjust reference point 
 The point will be automatically saved.

20、 The instruction of APEX LOCATOR display

(1)



(2)



(3)



- 1、 When the file reaches the front region of the apical foramen, the screen displays the white indicated strips (As shown in picture 1).
- 2、 When the file reaches the position near by the apical foramen, the screen displays the green indicated strips (As shown in picture 2).
- 3、 When the screen light the red indicated strips, means the file has exceeded the apical foramen, a rapid bee sound will be generated at the same time (As shown in picture3).

Warning



Avoid using apex locator for working length determination in the following conditions :

- (1) Open apex cases.
- (2) Draining canals.
- (3) Poor isolation from oral environment (avoid seepage of oral fluids into access cavity).
- (4) Root fractures / perforation.
- (5) Gutta percha filled canals ;

Please use the original accessories, otherwise the device may measure inaccurately or not even function.

Note



The green part "00" display means major apical foramen (not the minor apical foramen). Hence it is recommended to reduce the working length by 0.5-1 mm.

The device's screen do not show the actual length of the root canal, the number reducing only means a trend that file is progressing apically.

The gingival crevicular fluid / saliva / gingival polyp will interfere with device functioning. Hence it is recommended to isolate the tooth.

The accessories which contact with patient (file folder, lip hook/ lip clip) can be reused and should be sterilized by high temperature before every time use.

E-CONNECT connect with APEX LOCATOR

21、Connect

(1)

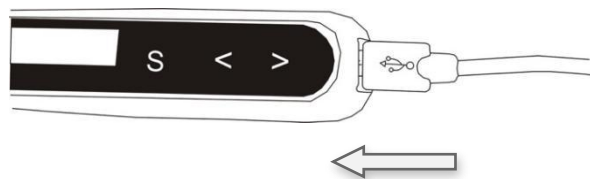

1、 Make sure E-CONNECT in standby

Open rubber cover , plug data transfer cable

(2)

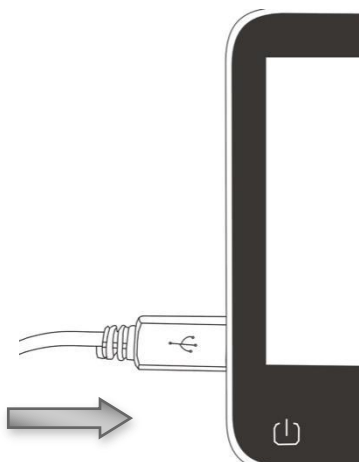

2、 Turn on the APEX LOCATOR, insert other end of data transfer cable into APEX LOCATOR

(3)

CONNECTED !

3、 After connect the cable , the screen of the E-CONNECT will display "CONNECTED !" shows the connection is properly.

22、 Connection operation

After connecting E-CONNECT and APEX LOCATOR , do the below step to make sure the device is working normally .

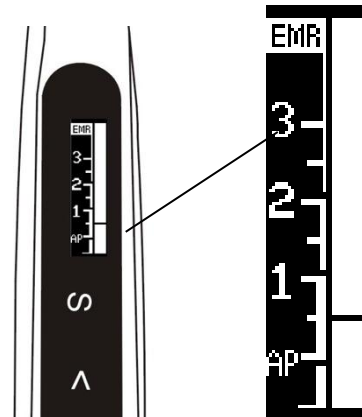
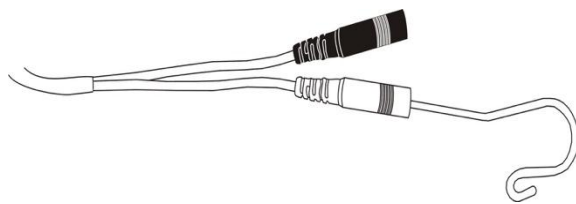
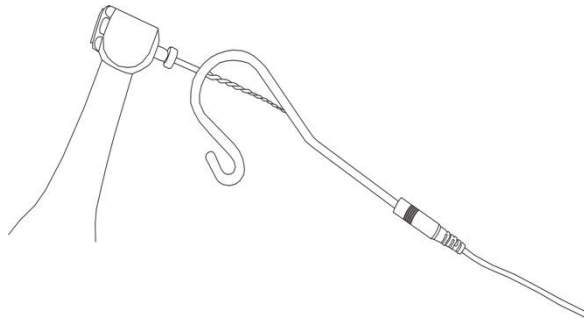

1. Insert the file into contra-angle handpiece, now contact the lip clip to file (short circuit).
2. Make file contra angle with lip hook (short circuit)
3. press the main switch of E-CONNECT , the root canal length strips that in the screen will be all lighted. That means the system is working normally.

After checking the system can working normally, user can hang the lip hook into the patient's mouth, and start the treatment.

23、 Display the root canal on E-CONNECT

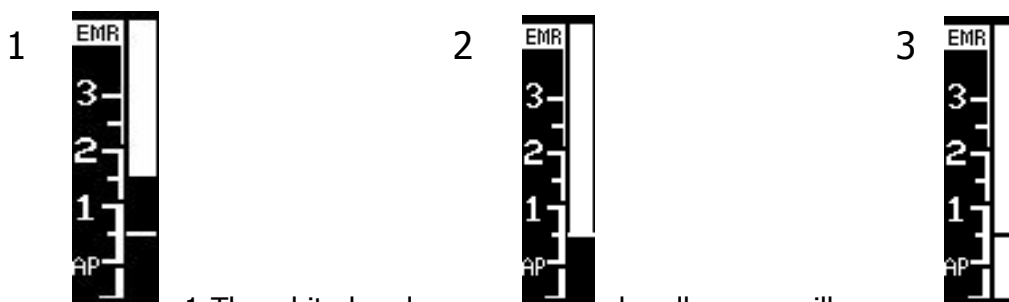

1. The white band on handle scree will display the progression of the file into the canals.
2. Closer the file tip to the canal apices, the more rapid the Beep sound.
3. After connection, will activate the advanced setting in 9.5.

24、 Combination Function



Set "ON" to choose the combination function



Set on to activate this function, when the file approach the root canal , motor will auto start , when the file leave the root canal, motor auto stop.



Operator can set Apical Reverse, Apical Slow Down and Apical Torque Reduction functions as described earlier refer to chapter 14 to set.

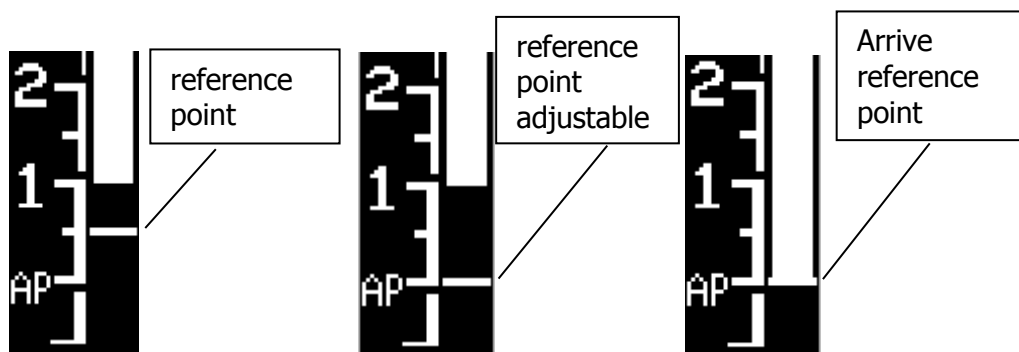

The position of the reference point is automatically setting with the APEX LOCATOR, and the cursor is displayed on the E-CONNECT screen.

When the file reaches the reference point, E-CONNECT will start **Apical Reverse ,Apical Slow Down** and **Apical Torque Reduction** function (If the function is activated) ,

Warning



Do not use a non - specified data transfer cable , otherwise will damage the device.

Do not hit device and splash liquids

Note



Make sure to connect the two devices with right position.

After connecting the two devices with the wire, gently push and pull the interface to ensure that the connection is stable, otherwise the data transmission may not be accurate.

in certain cases, for example when the canal is blocked, the measurement may be unable.

The will not be able to perform a precise measurement for every time, especially in cases of abnormal or unusual morphology of the root canal. The user need coordinate with x-ray to check the results of the measurement.

If the meter does not move when you enter the file, it is possible that the unit is not working normally, therefore, stop using.

25、 Cleaning, Disinfection and Sterilization

25.1 Foreword

For hygiene and sanitary safety purpose, the components (contra angle, file clip, lip hook and insulating sleeve) must be cleaned, disinfected and sterilized before each usage to prevent any contamination. This concerns the first use as well as the subsequent uses.

Comply with your national guidelines, standards and requirements for cleaning, disinfection and sterilization

25.2 General recommendations

The user is responsible for the sterility of the product for the first cycle and each further usage as well as for the usage of damaged or dirty instruments, where applicable after sterility.

For your own safety, please wear personal protective equipment (gloves, safety glasses, etc.).

Use only a disinfecting solution which is approved for its efficacy (VAH/DGHM-listing, CE marking, and FDA approval) and in accordance with the DFU of the disinfecting solution manufacturer.

The water quality has to be convenient to the local regulations especially for the last rinsing step or with a washer-disinfector.

Thoroughly clean and wash the components before autoclaving.

Do not lubricate the motor handpiece.

Do not clean the contra angle with an ultrasonic cleaning device.

Do not use bleach or chloride disinfectant materials.



Autoclavable Components

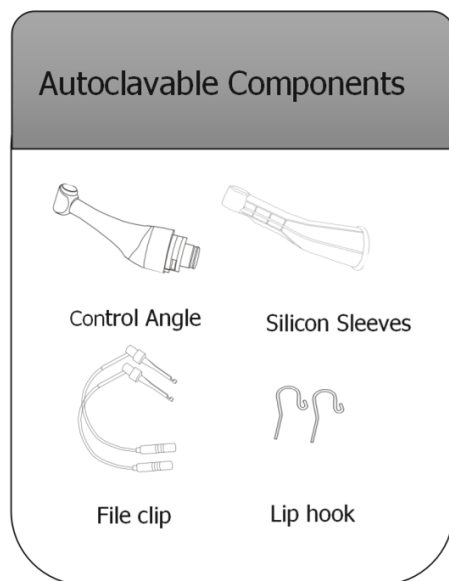







Warning

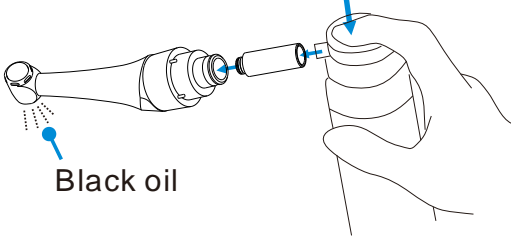

- Only the components above can be autoclaved.
- Before first use and after each use, sterilize the above components.

Autoclave Procedure:

STEP NO.	INSTRUCTIONS	
1	Initial treatment at point of use	<p>Immediately after using, wipe gross contaminations from the components (contra angle, file clip, lip hook and insulating sleeve), and put them in container for transportation.</p> <p>Prepare the components directly after treatment.</p> <p>Warning </p> <ul style="list-style-type: none"> • Do not submerge the components or wipe them with any of the following functional water (acidic electrolyzed water, strong alkaline solution, or ozone water), medical agents (glutaral, etc.), or any other special types of water or commercial cleaning liquids. Such liquids may result in metal corrosion and adhesion of the residual medical agents to the components.

2	Preparation before cleaning	<p>Remove and disconnect the components (Contra Angle, Lip Hook, File clip, Insulating Sleeve) before cleaning.</p> <p>Warning </p> <ul style="list-style-type: none"> ● Do not fail to take out the file before cleaning the contra angle. ● Observe suitable personal protective measures.
<p>The following Step 3 to Step 5 are operated in a washer-disinfector:</p> <p>Warning </p> <ul style="list-style-type: none"> ● Use only approved washer-disinfectors according to EN ISO 15883, maintain and calibrate it regularly. ● Follow instructions and observe concentrations given by the manufacturer (see general recommendations). ● Sufficient rinsing step should be available in purified water (max 10 germs/ml and max 0.25 endotoxin units/ml) ● Avoid any contact between the contra-angle and any instrument, kit, support or container. ● Make sure the components are dry before moving to the #6 step. 		
3	Cleaning: Automated	<ul style="list-style-type: none"> - Carefully put the components (Contra Angle, Lip Hook, File Clip, Insulating Sleeve) into the washer-disinfector and set the parameters as follows: - Pre-cleaning: water temperature <30°C, 2 min; - Cleaning: water temperature 45°C, 5 min; use an enzyme detergent solution (mild and aldehyde free solution) which is suitable to be used with washer-disinfector, and use in accordance with the IFU of the detergent solution manufacturer; - Rinsing: water temperature 45°C, 1 min (Rinsing twice).
4	Disinfection: Thermal	Thermal disinfection at least 5 min at 90°C/194°F, make sure A0 value ≥ 3000.
5	Drying	Heat, 20min, 90°C/194°F
6	Maintenance and Inspection	<ul style="list-style-type: none"> - Inspect components and sort out those with defects. Dirty components must be cleaned and disinfected again. - Only the contra angle needs to be lubricated.

		 <p>Warning </p> <ul style="list-style-type: none"> ● Before autoclaving, the contra angle must be lubricated. ● Attaching the spray nozzle to oil can and contra angle, press the oil can button more than 3 seconds, till all the black oil flow out from the head of the contra angle.
7	Packaging	<p>Pack each component in a separate steam-sterilization pouch.</p> <p>Warning </p> <ul style="list-style-type: none"> ● Check the validity period of pouch given by the manufacturer to determine the shelf life. ● Use pouches which resist to a temperature up to 141°C(286°F) and in accordance with EN ISO 11607.
8	Sterilization	<p>Steam sterilization at 134°C, at least 6 minutes.</p> <p>Minimum drying time after sterilization: 10 minutes.</p> <p>Warning </p> <ul style="list-style-type: none"> ● Use only approved autoclave devices according to EN 13060 or EN 285. ● Use a validated sterilization procedure according to ISO 17665. ● Respect the maintenance procedure of the autoclave device given by the manufacturer. ● Use only this recommended sterilization procedure. ● Control the efficiency (packaging integrity, no humidity, color change of sterilization indicators, physicochemical integrators, digital records of cycles parameters). ● The sterilization procedure must comply with ISO 17665. ● Wait for cooling before touching.

9	Storage	<p>Keep the components in sterilization packaging in a dry and clean environment.</p> <p>Warning </p> <ul style="list-style-type: none"> ● Sterility cannot be guaranteed if packaging is open, damaged or wet. ● Check the packaging and the contra angle before using it (packaging integrity, no humidity and validity period).
<p>Warning </p> <p>The instructions provided above have been validated by the manufacturer of the medical device as being capable of preparing a medical device for use. It remains the responsibility of the processor to ensure that the processing, as actually performed using equipment, materials and personnel in the processing facility, achieves the desired result. This requires verification and/or validation and routine monitoring of the process. Likewise, any deviation by the processor from the instructions provided should be properly evaluated for effectiveness and potential adverse consequences.</p>		

25.3 Disinfection

Disinfection Components

Wipe with Ethanol for Disinfection (Ethanol 70 to 80 vol%)



Mortor Handpiece & Handpiece Holder



Measuring wire



Data transfer cable



Charger

Wipe all the surfaces with a cloth lightly moistened with Ethanol for Disinfection (Ethanol 70 to 80vol%) at least 2 min, repeat for 5 times.

Note 

- Do not use anything except Ethanol for Disinfection (Ethanol 70 to 80 vol%).
- Do not use too much ethanol as it's going into machine and damage the components inside.

26、 Technical Data

Manufacturer	Changzhou Sifary medical technology Co.,Ltd
Model	E-CONNECT
Dimensions	20cm x 17.5cm x7cm (package)
Weight	700g
Contra-angle	Contra-angle compatible with rotary and reciprocating instruments, equipped with a 2.35 mm shaft conforming to ISO 1797-1:2011, Type 1
Power supply	Lithium ion battery: 3.7V, 1500mAh
Charger power supply	AC100-240V
Frequency	50/60Hz
Charger nominal power input	5.5VA
Torque range	0.5Ncm-4Ncm
Speed range of the micromotor shaft	120-1000 rpm
Electrical safety class	Class II
Applied part	BF
Ambient conditions	Use: in enclosed spaces Ambient temperature: 10°C / 40 °C Relative humidity: <80%; non-condensing at 0° Operating altitude < 2000 m above sea level
Transport and storage conditions	<ul style="list-style-type: none"> • Ambient temperature: -20 °C / +55 °C • Relative humidity: 20% - 80%, non-condensing at > 40 °C • Atmospheric pressure: 50 kPa - 106 kPa

Manufacturer	Changzhou Sifary medical technology Co., Ltd
Model	E-PEX
Dimensions	20cm x 17.5cm x7cm (package)
Weight	600g
Display	3.5' color LCD
Power supply	Lithium ion battery: 3.7V, 1500mAh
Charger power supply	AC100-240V
Frequency	50/60Hz
Charger nominal power input	5.5VA
Power Rating	0.3 W
Degree of Protection	IPX 0
Electrical safety class	Class II
Applied part	BF
Ambient conditions	Use: in enclosed spaces Ambient temperature: 10°C / 40 °C Relative humidity: <80%; non-condensing at 0° Operating altitude < 2000 m above sea level
Transport and storage conditions	<ul style="list-style-type: none"> • Ambient temperature: -20 °C / +55 °C • Relative humidity: 20% - 80%, non-condensing at > 40 °C • Atmospheric pressure: 50 kPa - 106 kPa

27、 EMC Tables

Guidance and manufacturer's declaration – electromagnetic emissions		
<p>The E-connect is intended for use in the electromagnetic environment specified below. The customer or the user of the E-connect should assure that it is used in such an environment.</p>		
Emissions test	Compliance	Electromagnetic environment - guidance
RF emissions CISPR 11	Group 1	<p>The E-connect uses RF energy only for its internal function. Therefore, its RF emissions are very low and are not likely to cause any interference in nearby electronic equipment.</p> <p>The E-connect is suitable for use in all establishments, including domestic establishments and those directly connected to the public low-voltage power supply network that supplies buildings used for domestic purposes.</p>
RF emissions CISPR 11	Class B	
Harmonic emissions IEC61000-3-2	Class A	
Voltage fluctuations/flicker emissions IEC 61000-3-3	Complies	

Guidance and manufacturer's declaration – electromagnetic immunity			
<p>The E-connect is intended for use in the electromagnetic environment specified below. The customer or the user of the E-connect should assure that it is used in such an environment.</p>			
Immunity test	IEC 60601 test level	Compliance level	Electromagnetic environment - guidance
Electrostatic discharge (ESD) IEC 61000-4-2	+/- 8 kV contact +/- 2 kV, +/- 4 kV, +/- 8 kV, +/- 15 kV air	+/- 8 kV contact +/- 2 kV, +/- 4 kV, +/- 8 kV, +/- 15 kV air	<p>Floors should be wood, concrete or ceramic tile. If floors are covered with synthetic material, the relative humidity should be at least 30 %.</p> <p>Mains power quality should be that of a typical</p>
Electrical fast transients/bursts	±2kV 100kHz repetition frequency	±2kV 100kHz repetition frequency	

IEC 61000-4-4			commercial or hospital environment.
Surge IEC 61000-4-5	Line to line: ±0.5kV, ±1kV Line to earth: ±0.5kV, ±1kV, ±2kV	Line to line: ±0.5kV, ±1kV Line to earth: ±0.5kV, ±1kV, ±2kV	Mains power quality should be that of a typical commercial or hospital environment.
Voltage dips IEC 61000-4-11	0% UT; 0.5 cycle at 0°, 45°, 90°, 135°, 180°, 225°, 270°, and 315° 0% UT; 1 cycle and 70% UT; 25/30 cycles sine phase at 0°	0% UT; 0.5 cycle at 0°, 45°, 90°, 135°, 180°, 225°, 270°, and 315° 0% UT; 1 cycle and 70% UT; 25/30 cycles sine phase at 0°	Mains power quality should be that of a typical commercial or hospital environment. If the user of devices require continued operation during power mains interruptions, it is recommended that devices be powered from an uninterruptible power supply or a battery
Voltage interruptions IEC 61000-4-11	0% UT; 250/300 cycle	0% UT; 250/300 cycle	
Rated Power frequency magnetic field IEC 61000-4-8	30 A/m 50Hz or 60Hz	30 A/m 50Hz or 60Hz	Power frequency magnetic field should be at levels characteristic of a typical location in a typical commercial or hospital environment.
Note: UT: rated voltage(s); E.g. 25/30 cycles means 25 cycles at 50Hz or 30 cycles at 60Hz			

Guidance and manufacturer's declaration – electromagnetic immunity

The **E-connect** is intended for use in the electromagnetic environment specified below. The customer or the user of the **E-connect** should assure that it is used in such an environment.

Immunity test	IEC 60601 test level	Compliance level	Electromagnetic environment - guidance
Conducted dis-turbances induced by RF fields IEC 61000-4-6	3 V 0.15 MHz – 80 MHz, 6 V in ISM bands between 0.15 MHz and 80 MHz, 80 % AM at 1 kHz	3 V	Portable and mobile RF communications equipment should be used no closer to any part of the E-connect , including cables, than the recommended separation distance calculated from the equation applicable to the frequency of the transmitter. Recommended minimum separation distances See the RF wireless communication equipment table in "Recommended minimum separation distances"
Radiated RF EM fields IEC 61000-4-3	3 V/m, 80 MHz – 2,7 GHz, 80 % AM at 1 kHz See the RF wireless communication equipment table in "Recommended minimum separation distances"	3V/m	
Proximity fields from RF wireless communication equipment IEC 61000-4-3	See the RF wireless communication equipment table in "Recommended minimum separation distances"	Complies	

Warning 

1. Use of accessories and cables other than those specified or provided by the manufacturer of **E-connect** could result in increased electromagnetic emissions or decreased electromagnetic immunity of **E-connect** and result in improper operation.

Cable information:

Cable Name	Cable Length (m)	Shielded or not	Remark
Adapter Cable	1.2	No	/

- Use of **E-connect** adjacent to or stacked with other equipment should be avoided because it could result in improper operation. If such use is necessary, **E-connect** and the other equipment should be observed to verify that they are operating normally.

28、 Statement

Service Life

The service life of Fast-Pack series products is 3 years.

Maintenance

MANUFACTURE will provide circuit diagrams, component part lists, descriptions, calibration instructions to assist to SERVICE PERSONNEL in parts repair.

Disposal

The package should be recycled. Metal parts of the device are disposed as scrap metal. Synthetic materials, electrical components, and printed circuit boards are disposed as electrical scrap. The lithium batteries are disposed as special refuse. Please deal with them according to the local environmental protection laws and regulation.

Rights

All rights of modifying the product are reserved to the manufacturer without further notice. The pictures are only for reference. The final interpretation rights belong to CHANGZHOU SIFARY MEDICAL TECHNOLOGY CO., LTD. The industrial design, inner structure, etc, have claimed for several patents by SIFARY, any copy or fake product must take legal responsibilities.



Changzhou Sifary Medcial Technology Co., Ltd

Add: NO.99, Qingyang Road, Xuejia County, Xinbei District, Changzhou City,
213000 Jiangsu, China

Tel: +86-0519-85962691

Fax: +86-0519-85962691

Email: ivy@sifary.com

Web: www.eighteeth.com



Llins Service & Consulting GmbH

Tel: +49 175 4870819

Add: Obere Seegasse 34/2, 69124, Heidelberg, Germany

Email: Llins.Service@gmail.com

Version: 02

IFU-6035001

Issued: 2019.11.11

All rights reserved.